

■ FC-02

■ Frangible Couplings (2-inch)



Compliance with Standards

SAC: GB/T 7256

ICAO: Doc 9157 Part 6

FAA: AC 150/5345-46

Application/Use

Applicable for installing elevated light on the flange

Features

- Forging of premium aluminum alloy material with thermal stability technology for even mechanical property
- Equal-strength structural design with even loading and less possibility of deforming
- High-precision machining, fully guarantees the quality and precision of bases
- Made of anti-corrosion aluminum with prior preservative treatment, durable in use

Structure

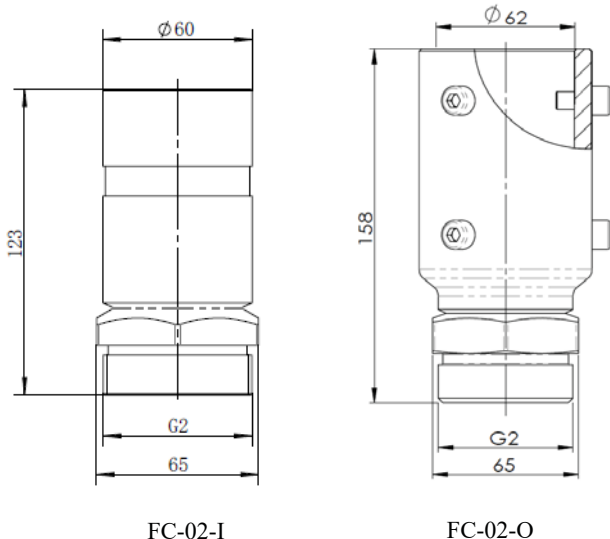

FC-02-I

FC-02-O

Packing Data

FC-02-I

20 x frangible Couplings
net weight: 0.46 kg

Packing size: 340×340×190 mm³
Gross eight: 11.3 kg

FC-02-O

16 x frangible Couplings
net weight: 0.64 kg

Packing size: 340×340×190 mm³
Gross eight: 12.3 kg

Ordering Information

FC-02-X-X

Type _____
FC-02 = 2-inch pipe thread Frangible Couplings

Connection Method _____
I = Insert in elevated light body base
O = Connect to the 2-inch extension pole

Thread Type _____
G = 55° cylindrical pipe thread
NPT = 60° american national taper pipe thread
NPS = 60° american national straight pipe thread

Installation

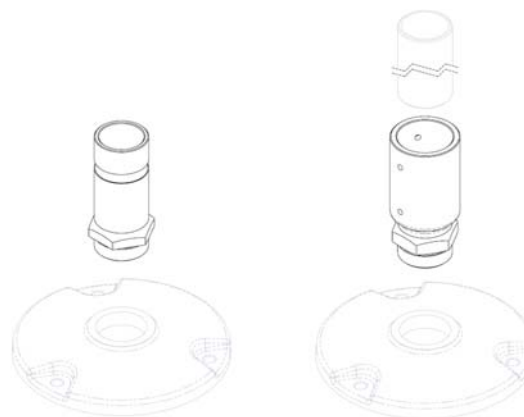

Fig 1. On FL-10 Flange

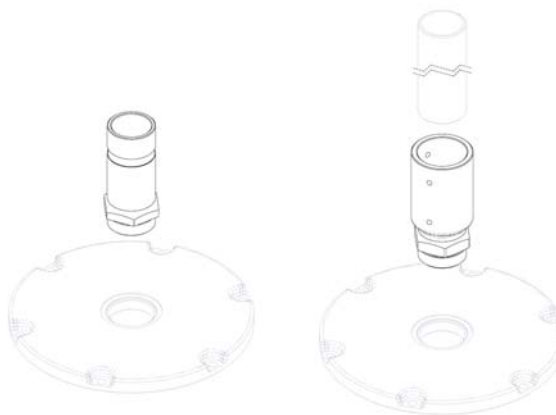

Fig 2. On FL-12 Flange

* All rights reserved, subject to modifications