

8 Inches LED In-pavement Taxiway Lighting Fixtures (6mm)

**Taxiway Centerline Light, In-pavement Stop Bar, Intermediate Holding Position Light and
In-pavement Runway Guard Light**

TCLMS-08-LED, SBLMS-08-LED, TPLMS-08-LED and IRGMS-08-LED

Operation Manual



Please read this manual carefully before construction, installation and operation of the product.

Please keep this manual properly for further reference.

This manual is subject to change without prior notice.

Airsafe Airport Equipment Co., Ltd.

Revision Description

No.	Description	Version No.	Revised by	Approved by	Date
1	First release	V1.0	Z.H	C.SY	Jul. 15, 2016

Table of Content

1.0 Foreword.....	1
1.1 Illustrations and Meanings	2
1.2 Safety Rules and Notices	3
1.3 Quality Assurance and Responsibility	4
2.0 Introduction.....	5
2.1 Technical Specifications	8
2.2 Application Environment	8
2.3 Application Scope.....	9
2.4 Technical Parameters	9
2.5 Technical Features	10
2.6 Structure.....	12
2.7 Fault Detection or Lamp Bypass Functions	13
3.0 Installation	15
3.1 Installation Methods	15
3.2 Identification of Different Types of Lighting Fixtures	16
3.3 Installation Tools	17
3.4 Screw and Torsion	18
3.5 Configuration of Lighting Fixtures and Relevant Installation Fittings	18
3.6 Installation Process	19
4.0 Operation and Control	21
4.1 Light Wiring Schematic Diagram.....	21
4.2 Light Intensity Adjustment and Control	21
5.0 Replacement of Components of Lighting Fixtures	22
5.1 How to Dismount the Lighting Fixtures from Base	23
5.2 How to Replace Prism and its Gasket Sleeve	24
5.3 How to Replace Light Source	25
5.4 Actions after the Light Source Assy is Replaced	26
5.5 How to Replace Gasket.....	27
5.6 Airtight Test of Lighting Fixtures	28
6.0 Maintenance of Lighting Fixtures	29
6.1 Daily Maintenance.....	29
6.2 Regular Spot Check and Troubleshooting	30
7.0 List of Components and Ordering of Spare Articles and Accessories	31
8.0 Packaging, Transportation and Storage	33
8.1 Packaging and Weight	33
8.2 Transportation Mode.....	33
8.3 Storage	33

1.0 Foreword

ICAO *Airport Service Manual* Part 9 “Airport Maintenance Practices” and FAA AC150/5345-26 *Maintenance of Airport Visual Aid Facilities* are the highest criterions for site installation and maintenance of such lighting fixtures. This manual was compiled with considerable reference to these two criterions.

The content stated in this manual is absolutely important, so construction personnel must read it carefully before construction. After properly understanding the entire content of this manual, construction personnel should carry out the construction in strict accordance with the methods specified herein, to ensure that the product is safely and properly installed in place.

Routine airport maintenance personnel should carry out the routine maintenance in strict accordance with the methods specified by relevant provisions, to ensure that the lighting fixtures are in the best operation condition.

Related personnel must strictly follow safety criterion. Any personnel without specialized training is strictly forbidden to touch the lighting fixtures and devices. Live line work should be avoided under any circumstances. Construction or maintenance personnel should get acquainted with first-aid knowledge, in case of any unexpected events.

1.1 Illustrations and Meanings

- Following illustrations will appear in this manual where necessary to remind or warn construction or maintenance personnel.
- Please continue reading the subsequent content of this manual after properly understanding the meanings of these illustrations.



- To remind that the behavior may cause serious injury or death.
- ※ Detailed description will be given in the box.



- To remind that the behavior may cause injury to people or damage to product.
- ※ Detailed description will be given in the box.



- To notify that the behavior is prohibited.
- ※ Detailed description will be given in the box.

1.2 Safety Rules and Notices



- Using the light fixtures outside of airport is strictly prohibited.
- ※ Inadequate maintenance or casual touch will cause light faults.



- Using power supply other than CCR is strictly prohibited.
- ※ It may damage the lighting fixtures and even cause fault of the power supply.



- Making sure that CCR is on power-off state before the installation or maintenance of the lighting fixtures.
- ※ Current surge produced during the installation of the lighting fixtures may cause damage to light source.



- Non-professional electricians are strictly forbidden to maintain any electrical fault of the lighting fixtures.
- ※ It may damage any electrical component of the lighting fixtures or cause bigger fault.



- Live line maintenance of the lighting fixtures is strictly prohibited; in case of lightning and/or thunderstorm, maintenance of the lighting fixtures is prohibited.
- ※ It may cause electric shock accident.



- Be careful when handling the lighting fixtures.
- ※ Drop or collision may damage the parts or cause personal injury.



- Replace the lead immediately in case the jacket of second cable is damaged.
- ※ It may cause short circuit, electric shock or other failure.



- Don't touch the damaged prism or other glass directly with hands.
- ※ Glass fragments may scratch hands.



- Touching the lighting fixtures with wet hand is strictly prohibited.
- ※ It may cause electric shock or other accident.

1.3 Quality Assurance and Responsibility

Any defect in design, material or workmanship, which may occur during proper and normal use over a period of one year from date of installation but less than 15 months from date of shipment, or within the warranty period of the tender, will be repaired or replaced by manufacturer free of charge. The warranty doesn't cover the failures resulting from lamp burnt out, improper maintenance, installation or operation, or damages due to snow ploughs. Manufacturer shall not be liable to any further claims or particularly claims for damages not affecting the goods themselves.

2.0 Introduction

This manual involves the following series lighting fixtures:

TCLMS-08-LED-----Taxiway Centerline Light

SBLMS-08-LED-----In-pavement Stop Bar

TPLMS-08-LED-----Intermediate Holding Position Light

IRGMS-08-LED----- In-pavement Runway Guard Light

Type of Taxiway Centerline Light (TCLMS-08-LED):

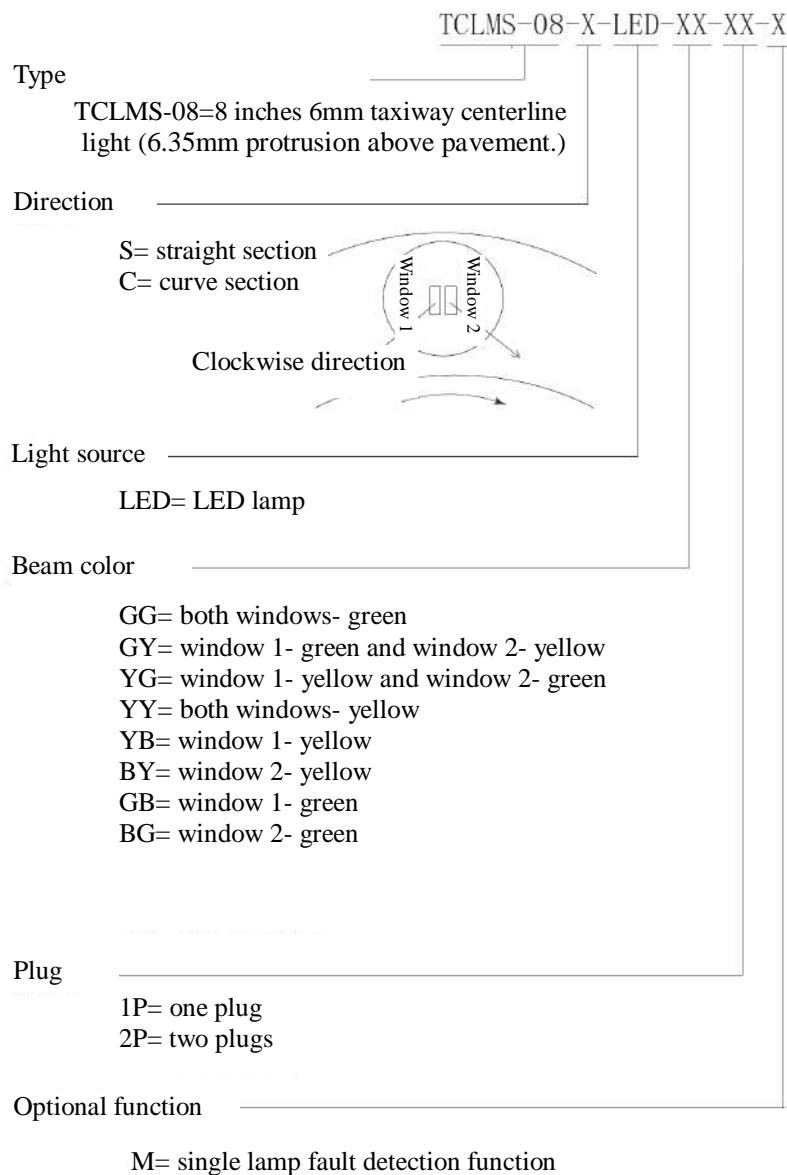

Type of In-pavement Stop Bar (SBLMS-08-LED):

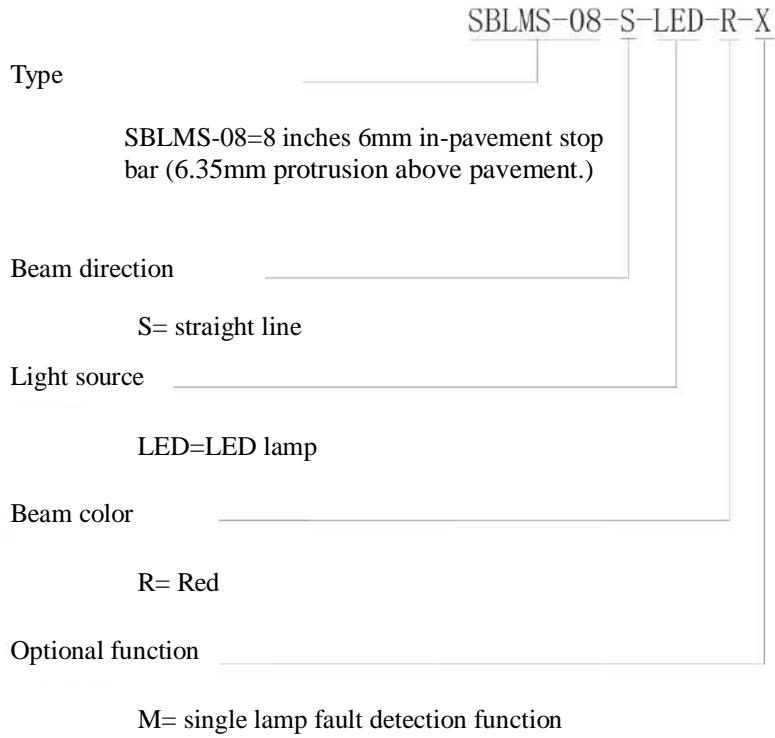

Type of Intermediate Holding Position Light (TPLMS-08-LED):

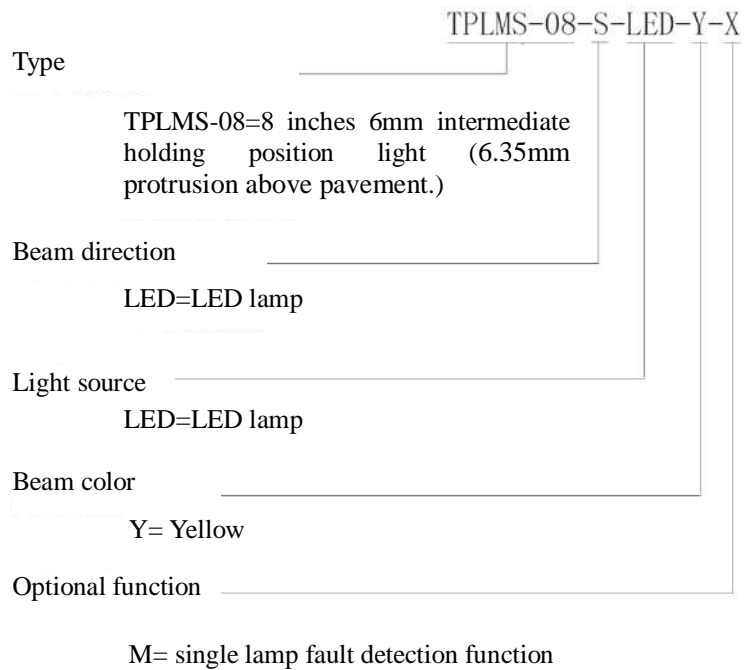

Type of In-pavement Runway Guard Light (IRGMS -08-LED):

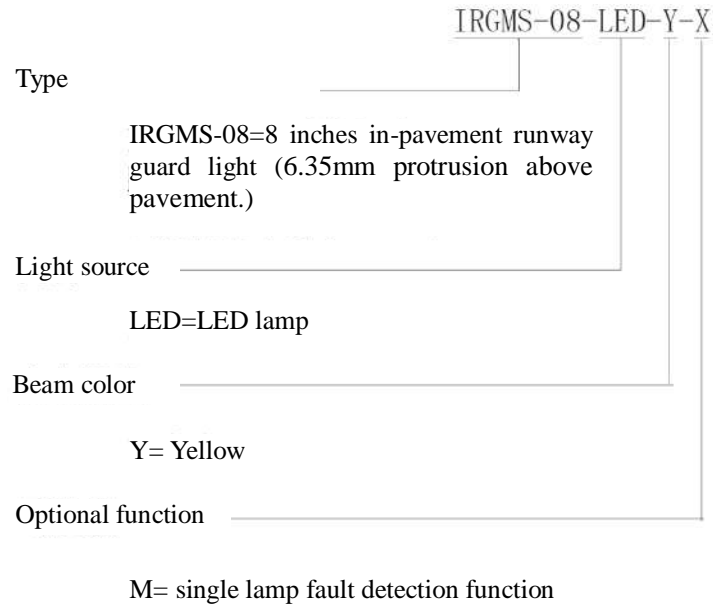

2.1 Technical Specifications

This product conforms to the provisions of the following standards or technical specifications. For dated standards or technical specifications, only the edition cited applies. For undated references, the latest edition of the referenced document (including any amendments) applies.

- International Electrotechnical Commission (IEC) TS 61827;
- Convention on International Civil Aviation Annex 14- *Aerodromes* Volume 1;
- International Civil Aviation Organization (ICAO)- *Aerodrome Design Manual*- Part 4: Visual Aids;
- Federal Aviation Administration (FAA) AC150/5345-46;
- Federal Aviation Administration (FAA) EB 67;
- GB/T 7256 *General Requirements of Lighting Fixtures for Civil Airport*;
- Department of Airport of Civil Aviation Administration of China: Advisory Circular, *Technical Requirements for Runway and Taxiway Aid Lighting Fixtures* (AC-137-CA-2015-03)
- Department of Airport of Civil Aviation Administration of China, Advisory Circular, *General Technical Requirements for Civil Airport LED Aid Lighting Fixtures* (AC-137-CA-2015-01)

2.2 Application Environment

- Altitude: below 4,000m;
- Outdoor: -55°C ~ +55°C;
- Relative air humidity: not more than 95%;
- In rain, snow, ice and water;
- Expose to corrosive salt atmosphere
- Basic earthquake intensity VII.

2.3 Application Scope

Taxiway centerline light, in-pavement stop bar, intermediate holding position light and in-pavement runway guard light for Category I, II and III airports.



- Using the lighting fixtures beyond the specified scope is strictly prohibited.
- ※ Application beyond the specified scope will cause damage or risk to any component.

2.4 Technical Parameters

Description	Type	Rated Power	Power Factor	Life of Light Source
Taxiway Centerline Light	TCLMS-08-S-LED-XX-1P	9VA	>0.9	≥50,000h
	TCLMS-08-S-LED-XB-1P	7VA	>0.9	≥50,000h
	TCLMS-08-S-LED-XX-2P	12VA (2×6VA)	>0.9	≥50,000h
	TCLMS-08-C-LED-XX-1P	9VA	>0.9	≥50,000h
	TCLMS-08-C-LED-XB-1P	7VA	>0.9	≥50,000h
	TCLMS-08-C-LED-XX-2P	12VA (2×6VA)	>0.9	≥50,000h
In-pavement Stop Bar	SBLMS-08-LED-R	8VA	>0.9	≥50,000h
Intermediate Holding Position Light	TPLMS-08-LED-Y	7VA	>0.9	≥50,000h
In-pavement Runway Guard Light	IRGMS-08-LED-Y	7VA	>0.9	≥50,000h



- In case of no special requirements, 25W isolation transformer lighting is recommended.
- ※ The isolation transformer of higher than 100W shall not be used for the light with the single lamp fault detection function.

2.5 Technical Features

- Long life, energy saving, maintenance free and other characteristics of LED will bring huge economic benefits to customers;
- Proprietary prism structure and manufacturing process, making the optical efficiency excellent;
- Strict LED color management ensures the consistency of light color;
- Dimming curve of the lighting fixtures is consistent with the change of halogen lamp, and meets the requirements of FAA;
- Proprietary drive circuit and thermal management solution greatly improve the reliability and service life of the lighting fixtures.
- Power factor is greater than 0.9, which minimizes the grid interference;
- Optional single lamp fault detection function enables the light to be open as halogen lamp once LED fails;
- Specifically designed lighting fixture structure and the lighting fixture is only 6.35mm protruded above the pavement;
- The luminous surface of the upper cover of the lighting fixture is flat, and thus it is difficult for ponding and the luminous efficiency is high;
- The upper cover of the lighting fixture employs the constant strength design and forging process, with good mechanical property and high bearing capacity and shock resistance capacity;
- The upper cover of the lighting fixture is smooth, without sharp corner angle to ensure that the aero tyre is not damaged;
- Main body of the lighting fixtures is made of the special high conduction aluminum alloy material and thus the lighting fixtures have good heat dissipation;
- Main body of the lighting fixtures is made of aluminum alloy material with special anodizing surface treatment, and all fasteners are made of stainless steel, thus being applicable to all kinds of harsh environment;

- High precision components machining ensures dimensional quality and precision of the lighting fixtures.
- The overall IP rating of the lighting fixtures reaches IP68, which may bear 138KPa internal pressure or water pressure formed by impact of the aircraft on the window;
- Optional double plugs respectively control the light of two windows, so as to achieve the intelligent circuit control;
- The components are of modularized designed for common use, which are applicable to various 8 inches LED in-pavement runway lights (6mm), effectively reducing the spare parts inventory.

2.6 Structure

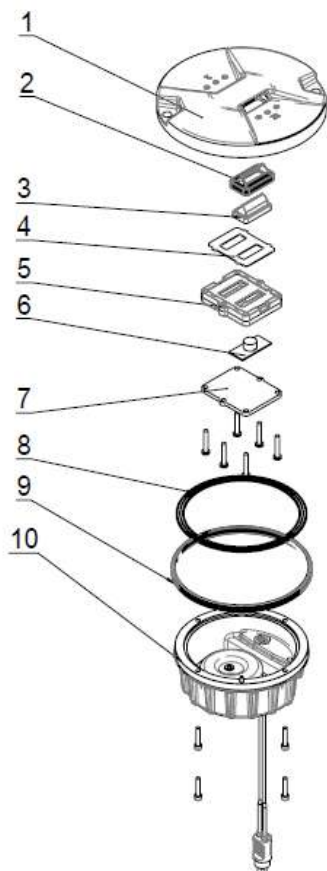

1. Upper cover
2. Prism gasket sleeve
3. Prism
4. Prism gasket
5. Prism pressing bracket
6. LED lamp assy
7. Heating panel
8. Body gasket
9. Lighting fixture gasket
10. Inner cover assy

2.7 Fault Detection or Lamp Bypass Functions

This product complies with the requirements of FAA EB67 and GB/T 7256, and integrates single lamp fault detection function; Or, it can provide the option of lamp bypass function in accordance with the requirements of FAA AC150-5345/46.

Single lamp fault detection function: The light will take automatic action to cut off the input when any malfunction occurs on the lamp and achieve an effect similar as the open circuit of ordinary halogen light once it is burnt. This function is generally used in conjunction with single lamp controller, to help single lamp control and monitoring system to identify any failed light. And it is integrated into the interior of the lighting fixtures, without need of any external device. Please specify this function during the ordering if needed.

25W isolation transformed is recommended and the transformer of greater than 100W shall not be used for such lighting fixtures.

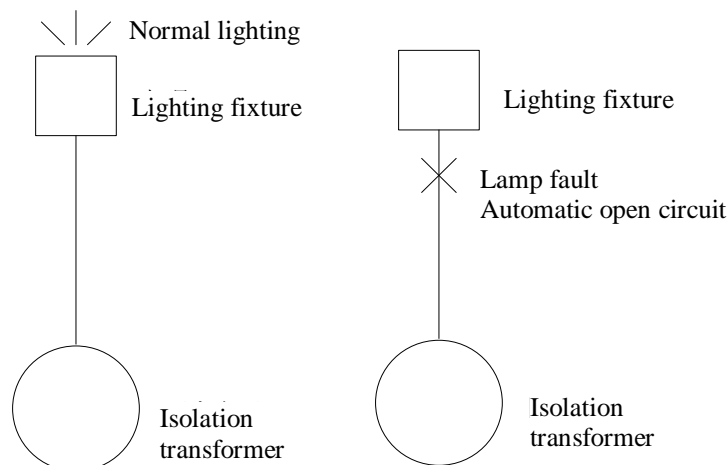

- In case of no special requirements, 25W isolation transformer is recommended for lighting.
- ※ Any isolation transformer whose power is greater than 100W shall not be used for the fixture that has the single lamp fault detection function.

Lamp bypass function: After any failure occurs to the lamp, relatively, the input terminal of light will be short to the isolation transformer. This function is generally applicable to occasions that one isolation transformer carries multiple lighting fixtures. If one or more of these lighting fixtures is or are damaged, the remaining lighting fixtures will not go out thereby. This function is

integrated into the interior of the lighting fixtures, without need of any external device. Please specify this function during the ordering if needed.

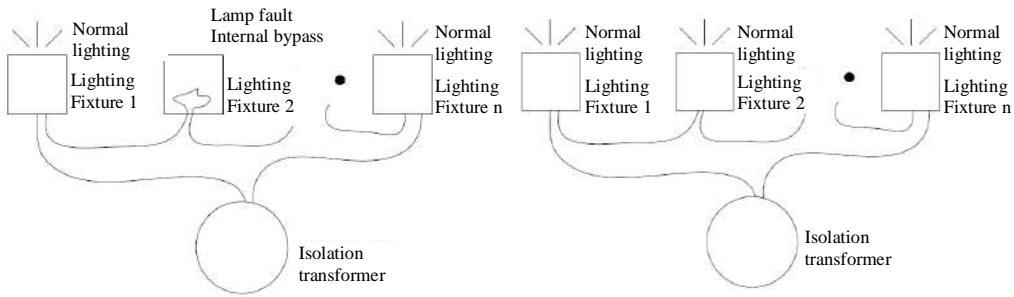

3.0 Installation

Requirements for installation should be learned thoroughly before installation including installation tools and site requirement, etc., to avoid malfunction of the light due to incorrect installation.

3.1 Installation Methods

- Directly mounted on the 8 inches shallow base (Figure 3-1).
- Mounted on the 12 inches shallow base with the 12/8 inches adapter ring (Figure 3-2).
- Mounted on the 12 inches deep base with the 12/8 inches adapter ring (Figure 3-3).
- The deep base depth may be adjusted according to the customer's requirements.

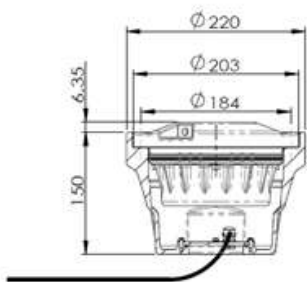

Figure 3-1

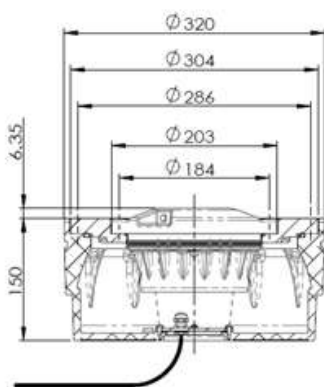

Figure 3-2

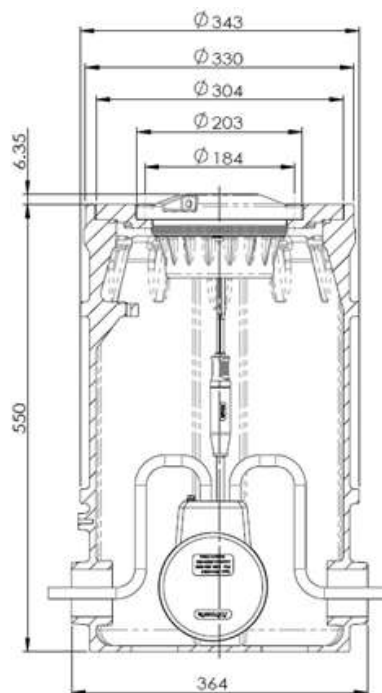
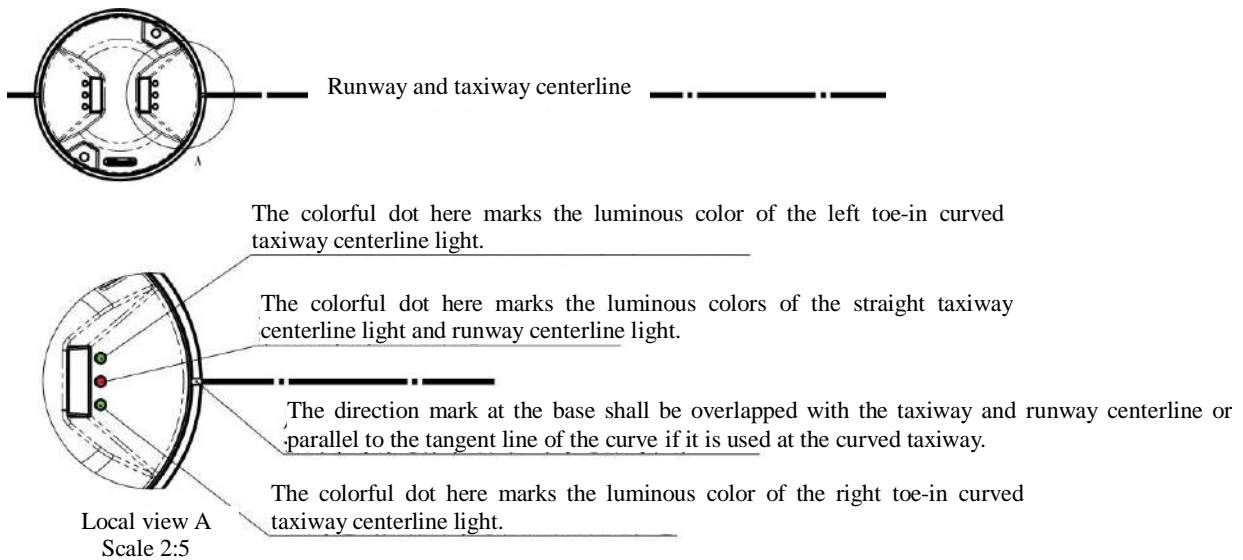



Figure 3-3

3.2 Identification of Different Types of Lighting Fixtures

- The model of each lighting fixture is attached to its bottom.
- The colorful dot identification mark is attached to the light outlet of each lighting fixture, respectively meaning the luminous color and direction of the window where the colorful dot is located.
- According to the specific provisions of FAA, ICAO and CAAC, correctly select the lighting fixtures and ensure their window directions.





- Before installing the lighting fixture, confirm the window color and luminous direction.
- ※ Avoid rework or other problems.

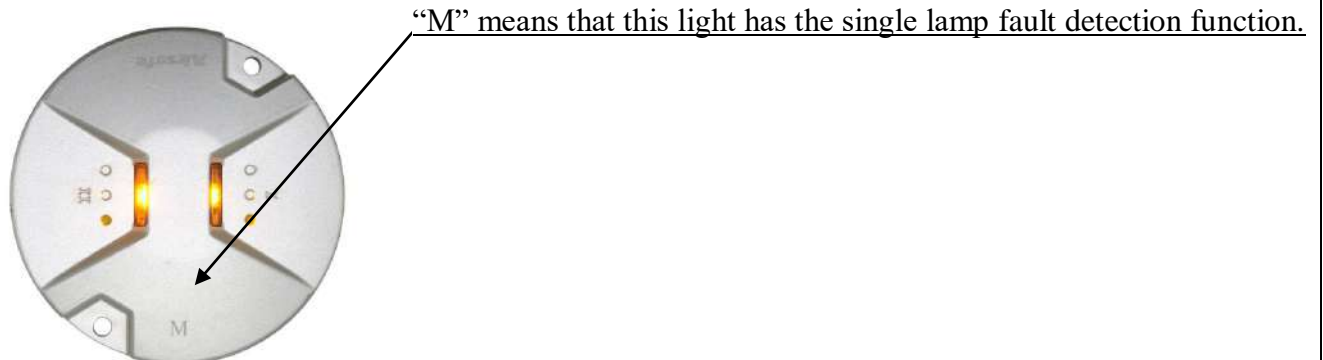

3.3 Installation Tools

Choosing right tools not only can ensure the correct and reliable installation of the lighting fixtures, but also can reduce unnecessary safety accidents. *Special Tools* listed in the table may be purchased from the manufacturer or any distributor. Universal tools are available on local hardware market. Please pay attention to measurement range during procurement.



- Special tool: 8 inches lighting fixture handle: be used to dismount the lighting fixtures, which has the patented design of the manufacturer and please directly order it from the manufacturer or agent.



- Universal tool: Torque wrench: be used to tighten the screw, which may be used with various sleeve wrenches and directly purchased from various hardware stores, manufacturer or agent. Recommended range is 10-40N·m.



- Universal tool- Torque screwdriver: be used to dismount screw, equipped with PH2 cross screwdriver, and sellable in various hardware stores. Recommended range is 1-6N.m

3.4 Screw and Torsion

The torque listed in this section is only for reference by maintenance personnel. Correct fastening force of screw can ensure normal operation of the lighting fixtures. If screw is too tight, it will easily damage the lighting fixtures; on the contrary, if screw is easy to fly out, it may cause an accident.

Serial No.	Screw Type	Tool	Torque
1	M10	Torque wrench with 17# sleeve	25 N·m
2	M5	Force measuring screwdriver with cross screwdriver (PH2) 3mm internal hexagonal wrench	3 N·m
3	M4	Force measuring screwdriver with cross screwdriver (PH2)	1.5 N·m
4	M3	Force measuring screwdriver with cross screwdriver (PH1)	0.63N·m



- Please use torque wrench or other special tool for installation.
- ※ Informal tools may cause damage to fasteners or personal injury.

3.5 Configuration of Lighting Fixtures and Relevant Installation Fittings

- 1、 M10×30 screw
- 2、 Ø10 spring washer
- 3、 Lighting fixture
- 4、 8 inches shallow base
- 5、 A7 twin-core receptacle (base assy)

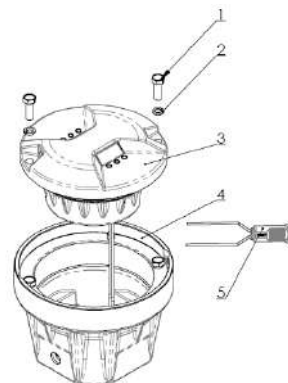

3.6 Installation Process

The installation process of lighting fixtures includes settings of the pavement mounting hole, wiring, base pre-burial and installation of lighting fixtures. The installation of lighting fixtures will greatly impact their use and service life. The manufacturer recommends that all installers should receive the professional training.

If ground connection is required, the ground lead shall be connected with the grounding screw on the lighting fixtures during its installation.

In case of installation with adapter ring or deep base, assemble the adapter ring to the base first and then perform the construction according to the above-mentioned method.

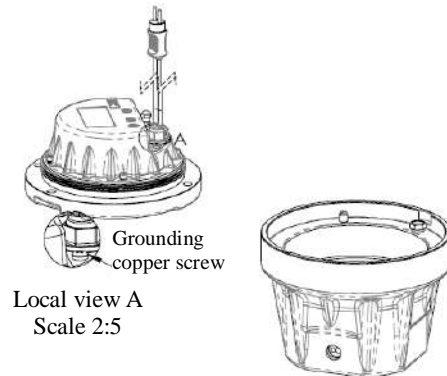

	<ul style="list-style-type: none"> ■ Before the lighting fixtures are installed, the dust on the base must be strictly cleaned. ※ It may cause leakage between the lighting fixture and base.
--	---

	<ul style="list-style-type: none"> ■ The ground lead must be connected in strict accordance with the provisions. ※ During daily maintenance, electric shock accident may be caused.
--	---

During installation, a little of water shall be used to wet the gasket of the lighting fixtures or base seal for lubrication. Then, plug the secondary plugs to ensure good contact.

The method is the same for installation with the adapter ring or deep base.

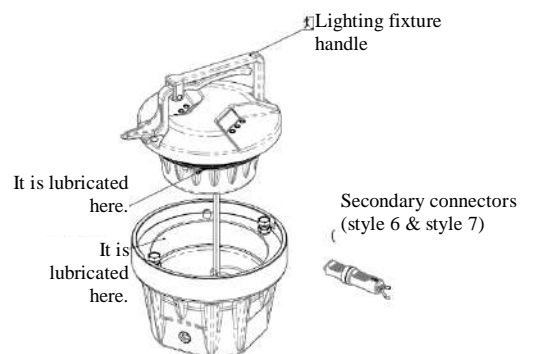



- During installation, the oily lubricating agent shall not be used to lubricate the sealing components.
- ※ The oily lubricant may cause aging or fault of the sealing components.



- The weight of the isolation transformer shall not be directly applied to the lead.
- ※ It may cause cable break, short circuit, drop, injury or other faults.

Clamp the lighting fixtures with the lighting fixture handle, reasonably put the secondary plug into the base to prevent the cable from squeezing during the installation, align the mounting holes of lighting fixtures and base, vertically apply force to press the lighting fixtures into the base and tighten the screw.

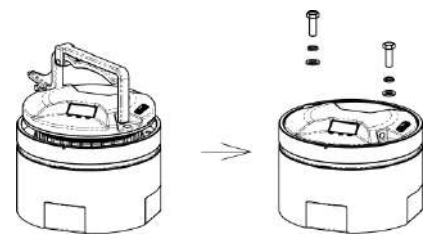

The method is the same for installation with the adapter ring or deep base.



- During installation, the lead shall not be damaged by the lighting fixtures.
- ※ It may cause electric leakage or short circuit of the lighting fixtures.



- During installation, the lighting fixture shall be pressed into the base, and not warped.
- ※ It may cause leakage between the lighting fixture and the base or other lighting fixture faults.



- Directly pulling the lead is prohibited when the lighting fixtures are handled.
- ※ It may cause line break, short circuit, drop, injury or other faults.

4.0 Operation and Control

The lighting fixtures are applicable to CCR power supply 6.6A circuit special for airports, which forms a secondary circuit with the lighting fixtures through secondary lead of isolation transformer connected on primary circuit. Due to the use of isolation transformer, the damage of lamp of single lighting fixture will not affect whole series circuit.

4.1 Light Wiring Schematic Diagram

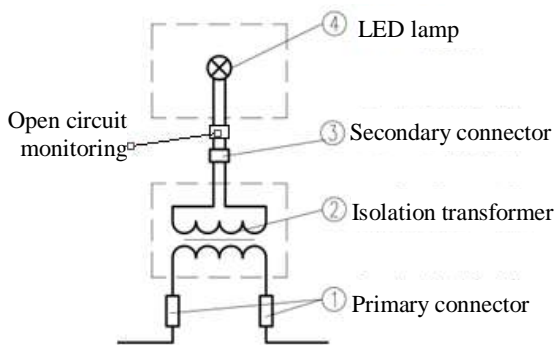

4.2 Light Intensity Adjustment and Control

In actual use, according to weather visibility, light intensity of the lighting fixtures may be adjusted through different current output by CCR, and varies significantly. If it is used on occasion of lower than rated current (6.6A), it may greatly improve the service life of lamp.

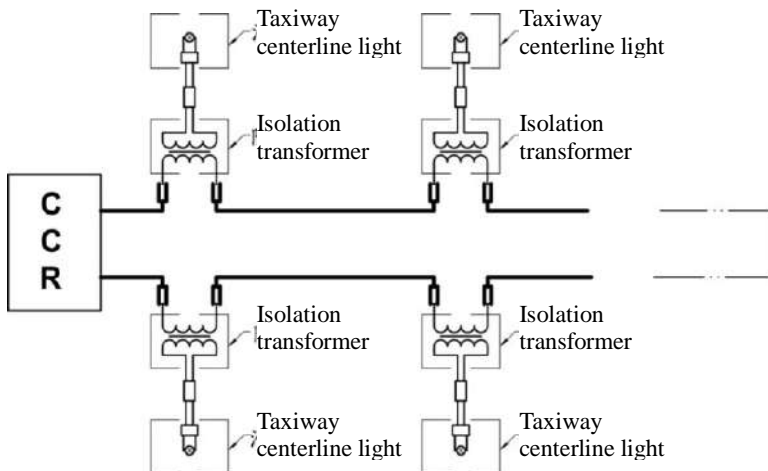

- Using power supply other than CCR is strictly prohibited.
- ※ Other power supply may cause damage to light source or other assy of the lighting fixtures, or even malfunctions of power supply.

5.0 Replacement of Components of Lighting Fixtures

When any damage or failure occurs to any consumable or other component of the lighting fixtures, it is required to timely dismantle the lighting fixtures for replacement of the component. Replacement of components needs to dismantle the lighting fixtures, so any minor error will cause adverse consequences. The manufacturer requires users to attach importance to the following warnings. It is required to be careful during disassembly, to conduct comprehensive inspection of lighting fixtures, to replace some vulnerable parts as required, and to ensure the performance of the lighting fixtures after disassembly.



- It is suggested that maintenance of the lighting fixtures be carried out in lighting station or workshop.
- ※ Any impurities mixed in the lighting fixtures may cause failure of the lighting fixtures.



- When the lighting fixtures are dismantled each time, M10×30 complete set of fasteners shall be replaced.
- ※ The fatigue damage of the screw and elastic failure of the spring washer may cause accident.



- The manufacturer suggests that various gaskets should be replaced during each maintenance of the lighting fixtures.
- ※ Aging and damage of gaskets are the main reasons for the leakage of lighting fixtures.

5.1 How to Dismount the Lighting Fixtures from Base

- Dismount M10×30 screw, washer and spring washer (see Figure 5-1).
- Pry up the lighting fixture with the pinch bar (shown in Figure 5-2) of the 8 inches lighting fixture handle.
- After the lighting fixture and base are loosened, vertically lift the lighting fixture with the lighting fixture handle and dismount the ground lead with the cross screwdriver (see Figure 5-3).



Figure 5-1



Figure 5-2



Figure 5-3



- Use the special handle supplied by the manufacturer when the lighting fixture is dismantled.
- ※ Drop of lighting fixtures may cause personal injury.

5.2 How to Replace Prism and its Gasket Sleeve

- Place the lighting fixture top downwards and dismount 4 M5×25 hexagon socket cap screws (Figure 5-4).
- Unplug the line connector of the LED lamp and circuit board and separate the upper cover and inner cover of the lighting fixtures (Figure 5-5).
- Dismount 6 M5×16 screws and remove the mounting plate of the aluminum substrate and prism pressing bracket (containing LED lamp) (see Figure 5-6).
- Take out the prism and its gasket sleeve from the upper cover and load the new prism gasket sleeve and prism into the upper cover in succession (see Figures 5-7 and 5-8).
- Press the aluminum substrate and prism pressing bracket (containing LED lamp) by aiming at the opposite angles of the screw hole (see Figure 5-9).
- Connect the lead of the LED lamp with the line connector on the circuit board, the pin hole in the inner cover aims at the pin on the upper cover and screw 4 socket head cap screws (see Figures 5-10 and 5-11).

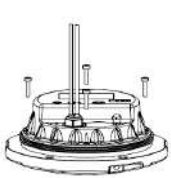

Figure 5-4

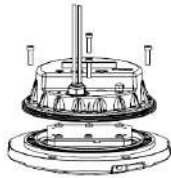

Figure 5-5



Figure 5-6



Figure 5-7



Figure 5-8



Figure 5-9



Figure 5-10

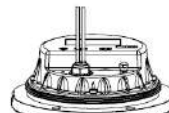

Figure 5-11



- The old rubber gasket sleeve shall not be used repeatedly.
- ※ Aging and damage of the rubber gasket sleeve may cause water seepage and leakage of the lighting fixtures.



- After the internal fittings of the lighting fixture are replaced each time, check the airtightness of the lighting fixtures.
- ※ Poor assembly may cause leakage of the lighting fixtures.

5.3 How to Replace Light Source

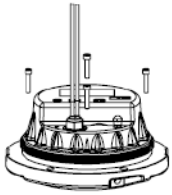

Figure 5-12

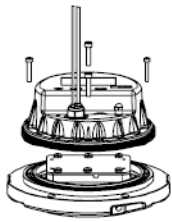

Figure 5-13

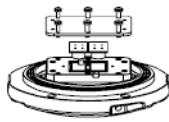

Figure 5-14



Figure 5-15

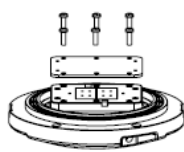

Figure 5-16

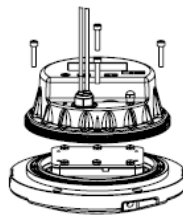

Figure 5-17

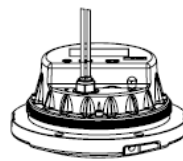

Figure 5-18

- Place the lighting fixture top downwards and dismount 4 M5×25 hexagon socket cap screws (Figure 5-12).
- Unplug the connecting cable connector of the LED lamp and circuit board and separate the upper cover and inner cover of the lighting fixtures (Figure 5-13).
- Dismount 6 M5×16 screws and remove the mounting plate of the aluminum substrate (see Figure 5-14).
- Take out the old LED lamp from the prism pressing bracket and replace a new light source (see Figures 5-15).
- Cover mounting plate of the aluminum substrate and screw 6 M5×16 screws at the opposite angles (see Figure 5-16).
- Connect the lead of the LED lamp with the clamp connector on the circuit board, the pin hole in the inner cover aims at the pin on the upper cover and screw it (see Figures 5-17 and 5-18).

5.4 Actions after the Light Source Assy is Replaced

For the lighting fixture integrating the single lamp fault detection function, after the single lamp monitoring system sends the notice of light source fault, the operator may replace it during the runway maintenance period according to the operation steps in 5.1.

For the replaced lighting fixture, the light source may be replaced according to the steps in 5.3. However, prior to completion of overall assy, the “reset switch” in the inner cover shall be clicked, please see the position in Figure below.

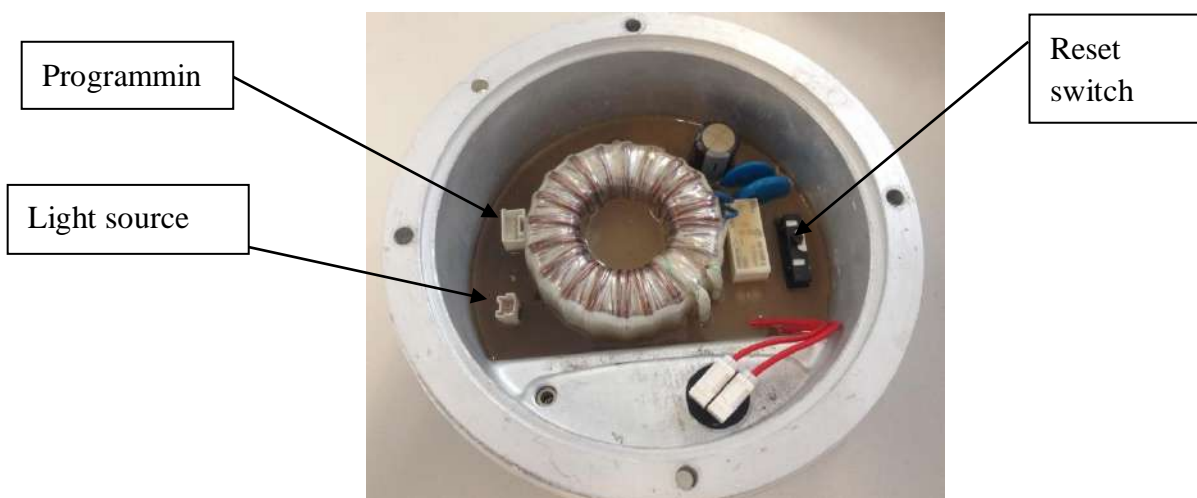

Connect the lighting fixture with the isolation transformer (25W or below is recommended), start at any lighting level of CCR and wait for several seconds. If the lighting fixture may work normally, it may be used after replacement and assembly according to the requirements in 5.5 and 5.6. If it does not work normally, please replace the inner cover or contact us.

5.5 How to Replace Gasket

- Replace the lighting fixture gasket outside the inner cover: Take down the lighting fixture gasket outside the inner cover and carefully clean the seal groove. Load the new gasket to the correct working position on the inner cover. Please note that the gasket shall not be bent (Figure 5-19).
- Replace the body gasket: Separate the inner cover and upper cover (Figure 5-20) and carefully clean the seal groove. Put the new gasket into the seal groove of the upper cover (pin orientation) and confirm that it is in place (Figure 5-21).
- Align the pin hole of the inner cover with the pin of the upper cover and connect it with M5×25 hexagon socket cap screws (Figures 5-22 and 5-23).

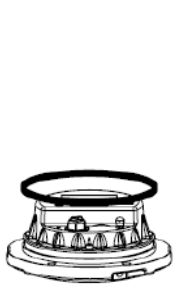

Figure 5-19

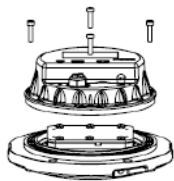

Figure 5-20

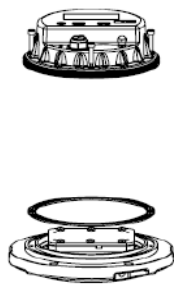

Figure 5-21

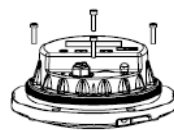

Figure 5-22



Figure 5-23



- Gasket should not be taken out from bag before assembly.
- ※ Any impurities on the gasket may cause water seepage of the lighting fixtures.



- Carefully check the gasket and seal groove to ensure that there are no impurities.
- ※ Impurity inclusion is the main cause of lighting fixture leakage.



- ※ The force shall be uniformly applied to the screws at the opposite angles, which shall be screwed gradually.
- ※ Improper assembly cause in water seepage of the lighting fixtures.



- Ensure that the gasket is located in the seal groove of the upper cover to prevent it from being cut.
- ※ It may cause lighting fixture leakage.

5.6 Airtight Test of Lighting Fixtures

- Unscrew the valve cap at the lighting fixture bottom (see Figure 5-24).
- Prepare 138Kpa air source (the air pressure shall not be greater than 150Kpa) and applicable air gun (air tube), inflate the air by aiming at the valve (Figure 5-25) until the air pressure in the lighting fixture meets the requirements. Put this lighting fixture into the water with the depth of 76mm for at least 1min and check whether there are bubbles under the state of static water surface. If not, it means that the sealing property of the lighting fixture is good, otherwise it shall be deemed that the lighting fixture has leakage.
- After detection, release the air pressure in the lighting fixture with the air valve of the valve core, re-screw the valve cap and put it into use (Figure 5-26). In case of leakage, check the causes according to the previous prompts and repeat the whole lighting fixture disassembly and assembly process or return it to the factory for maintenance.

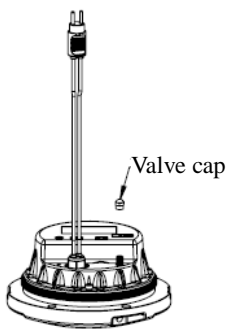

Figure 5-24

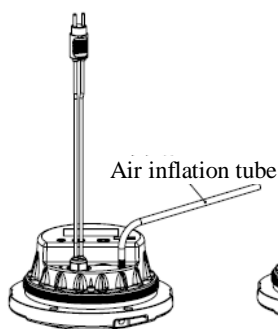

Figure 5-25

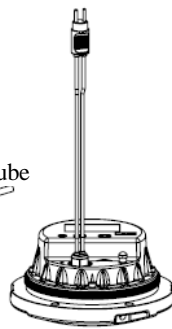

Figure 5-26



- After installation, the leakage test must be performed according to the requirements.
- ※ Improper assembly may cause leakage of the lighting fixtures.



- Unscrewing the valve is prohibited, when the valve cap is unscrewed.
- ※ Otherwise it may cause leakage of the lighting fixtures.

6.0 Maintenance of Lighting Fixtures

Suggestions for daily maintenance provided in this section are only for reference. Airports may formulate their own daily maintenance guidelines with reference to other provisions or maintenance experience of airport staff; the manufacturer does not provide any hard-and-fast rules. Maintenance of the lighting fixtures for airports shall be conducted by professionals as stated in 1.0 Foreword.

6.1 Daily Maintenance

Interval	Check	Activity
Every day	No light output or flashing	Replace LED lamp assy.
	Light output is lower	<ol style="list-style-type: none"> 1. Clean the prism surface if it is dirty. 2. Check deviation or moisture of the lighting fixtures. 3. Check aging or displacement of LED.
Every week	Obstacles to light output channel	Clean the path and prism surface.
Every month	Existence of moisture and water (Visual check of internal surface of prism)	<ol style="list-style-type: none"> 1. Open the body. 2. Clean, dry and check. 3. Replace the gasket of the light body and other parts damaged.
Every two months	Tighten the screws	<p>Check whether screw for tightening light body is locked.</p> <p>Use the tools such as wrench and sealant by referring to the Table in Section 3.4.</p>
Every half a year	Water in the base	<ol style="list-style-type: none"> 1. Pump out the water in the base. 2. Move and dismantle it and observe the damage to the lighting fixtures by water. 3. Dispose of the water inlet.
After snow removal	Damage to lighting fixtures	<ol style="list-style-type: none"> 1. Replace seriously damaged light.
After snow removal	Light output is lower	<ol style="list-style-type: none"> 1. Sweep the snow on the window with a powerful sweeper. 2. Clean the prism surface if it is dirty. 3. Check deviation or moisture of the lighting fixtures. 4. Check aging or displacement of LED.

6.2 Regular Spot Check and Troubleshooting

Serial No.	Failure Phenomenon	Possible Reasons	Countermeasures
1	No light output or flashing	LED aging or other unknown failure. Power of the isolation transformer of greater than 100W.	Replace the LED lamp assy or driver or return the lighting fixtures to the manufacturer for maintenance.
2	The lighting fixtures is darker	The prism surface is dirty.	Clean the prism surface.
3	Existence of moisture and water	Damage to the prism or gasket	Replace the prism or gasket.



- The manufacturer suggests that times of daily maintenance should be increased in rainy season.
- ※ To ensure normal operation of lighting fixtures.



- The manufacturer suggests that the lighting fixtures should be systematically replaced when the service life of the LED lamp reaches 80%.
- ※ To ensure the consistency of light intensity of whole circuit.



- It is necessary to use torque wrench. Power wrench is strictly prohibited.
- ※ Otherwise, it may damage screw and thread, and thus cause an accident.

7.0 List of Components and Ordering of Spare Articles and

Accessories

The table in this chapter lists the components, spare articles and accessories of this product and relevant ordering information. Spare articles and accessories of this product needs to be ordered additionally, and the manufacturer accepts the order in assembly mode and separate order of components. When ordering, please contact the manufacturer or any distributor according to order number listed in the table. The manufacturer suggests that some important components should be purchased from original factory to ensure various indicators of the lighting fixtures.

List of components and spare articles:

Structure No.	Component Name	Order No.	Description
1	Upper cover	921561/ 921571	Upper cover (ridge H6)- component/ upper cover (ridge uni-directional H6)-F
2	Prism gasket sleeve	43111	Ridge prism gasket sleeve H15
3	Prism	31151/31152/ 31153	Ridge prism (H19 straight line)/ ridge prism (H19 left tilted)/ ridge prism (H19 right titled)
4	Prism gasket	43313	Prism gasket (66×51) LED
5	Prism pressing bracket	4321A	Prism pressing bracket (79×64)
6	LED lamp assy	79221-G-01 green 79221-Y-01 yellow 79231-GY-01 green-yellow 79231-GG-01 green-green 79231-YY-01 yellow-yellow	LED lamp 1P-0 (green) standard/ LED lamp 1P-0 (yellow) standard/ LED lamp 2×1P-O/O (green-yellow) standard/ LED lamp 2×1P-O/O (green-green) standard / LED lamp 2×1P-O/O (yellow-yellow) standard/
7	Heating panel	46441	Heating panel (78×63)
8	Light body gasket	41141	Gasket 137×2
9	Lighting fixture	41107	Sealing gasket (standard)

	gasket		
10	Inner cover assy (including valve and A6 twin-core plug)	921251-1 921251-O-1 921253-D	Inner cover (H59-F)-single circuit/ Inner cover (H59-F)-Open circuit module –single circuit/ Inner cover H59-F- double control (including the open circuit module)

List of supporting accessories of this product is as follows (needing additional order):

Serial No.	Order No.	Description
1	827131	8 inches shallow base assy (side entry)
2	827132	8 inches shallow base assy (bottom entry)
3	70703	Secondary receptacle A7
4	951101	8 inches lighting fixture handle
5	827511	12-8 adapter ring assy
6	82732X	12 inches deep base (H550) assy
7	927151	12 inches shallow base assy (bottom entry)
8	927156	12 inches shallow base assy (side entry)
9	ITF-025-066	Isolation transformer 25W



- When the prism cannot work properly, please order it from our company.
- ※ The prism of other brands may impact the luminous angle and light intensity of the lighting fixtures.



- If secondary plug is damaged, please order it from our company.
- ※ Other brand plug may cause light leakage and other failures.

8.0 Packaging, Transportation and Storage

8.1 Packaging and Weight

Packaging: 2 pcs / box

Gross weight: 7.59 KG / box

Volume: 220*220*230 mm³

Packaging: 1 pcs / box (including 8 inches shallow base)

Gross weight: 6.5 KG / box

Volume: 250*250*185 mm³

8.2 Transportation Mode

Well packed products may be transported in three modes- railway, highway and air according to factors such as transportation distance, quantity of lights and delivery cycle.

8.3 Storage

This product shall be stored in a place which is dry, well ventilated and far away from heat source and has no caustic gas. Custody should be checked on a regular basis.

The final right to interpret this manual is reserved by Airsafe Airport Equipment Co., Ltd.

Thanks for your purchasing and using AIRSAFE product!

Address: No. 38, Anxin Road, Xuhang Town,
Jiading District, Shanghai, China

Postal Code: 201800

Tel.: 021-53540453

Fax: 021-63643114

E-mail: sales@airsafe.com.cn